



3mm Silicon PIN Photodiode

MODEL NO : PD204-6B

■ Features :

- Fast response time
- High photo sensitivity
- Small junction capacitance

■ Description :

PD204-6B is a high speed and high sensitive PIN photodiode in a standard 3Φ plastic package. The device is spectrally matched to infrared emitting diode.

■ Applications :

- High speed photo detector
- Camera
- Optoelectronic switch
- VCRs ,Video camera
- Floppy disk drive

PART NO.	CHIP	LENS COLOR
	MATERIAL	
PD	Silicon	Black

3mm Silicon PIN Photodiode

MODEL NO : PD204-6B

■ Package Dimensions :

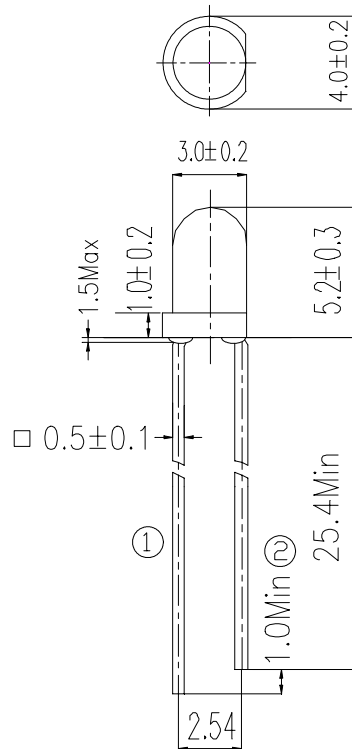

① Anode
② Cathode

■ Notes :

1. All dimensions are in millimeter.
2. Protruded resin under flange 1.5 mm Max.
3. Lead spacing is measured where the lead emerge from the package.
4. Lens color : Black.
5. Above specification may be changed without notice. EVERLIGHT will reserve authority on material change for above specification.
6. These specification sheets include materials protected under copyright of EVERLIGHT corporation . Please don't reproduce or cause anyone to reproduce them without EVERLIGHT's consent.
7. When using this product , please observe the absolute maximum ratings and the instructions for use outlined in these specification sheets. EVERLIGHT assumes no responsibility for any damage resulting from use of the product which does not comply with the absolute maximum ratings and the instructions included in these specification sheets.

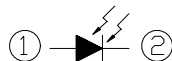



EVERLIGHT ELECTRONICS CO., LTD.

DEVICE NUMBER : DPD-020-040 REV : 1.1
 ECN : _____ PAGE : 3/7

3mm Silicon PIN Photodiode

MODEL NO : PD204-6B

■ Absolute Maximum Ratings at T_A = 25°C

Parameter	Symbol	Rating	Unit	Notice
Reverse Voltage	V _R	32	V	
Power Dissipation	P _d	150	mW	
Lead Soldering Temperature	T _{sol}	260	°C	4mm from mold body less than 5 seconds
Operating Temperature	T _{opr}	-25 ~ +85	°C	
Storage Temperature	T _{stg}	-40 ~ +85	°C	

■ Electronic Optical Characteristics :

Parameter	Symbol	Min.	Typ.	Max.	Unit	Condition
Rang of Spectral Bandwidth	$\lambda_{0.5}$	----	840-1200	----	nm	-----
Wavelength of Peak Sensitivity	λ_p	----	980	----	nm	-----
Open-Circuit Voltage	V _{oc}	----	0.42	----	V	E _e =5m W/c m ² λ _p =940nm
Short-Circuit Current	I _{sc}	----	15	----	μA	
Reverse Light Current	I _L	----	15	----	μA	E _e =5m W/c m ² λ _p =940nm V _R =5V
Dark Current	I _d	----	----	10	nA	E _e =0m W/c m ² V _R =10V
Reverse Breakdown Voltage	BV _R	32	170	----	V	E _e =0m W/c m ² I _R =100μA
Total Capacitance	C _t	----	5	----	pF	E _e =0m W/c m ² V _R =5V, f=1MHz
Rise/Fall Time	t _r /t _f	----	6/6	----	nS	V _R =10V R _L =1KΩ



3mm Silicon PIN Photodiode

MODEL NO : PD204-6B

■ Typical Electrical/Optical/Characteristics Curves

Fig. 1 Power Dissipation vs. Ambient Temperature

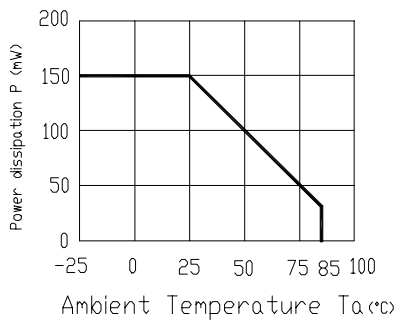

Fig. 2 Spectral Sensitivity

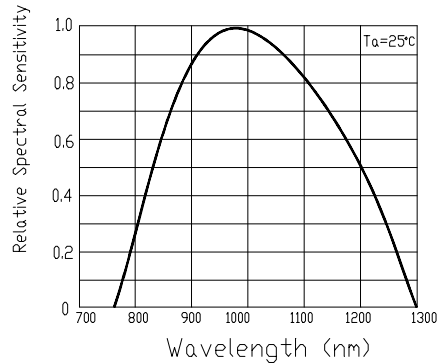

Fig.3 Dark Current vs. Ambient Temperature

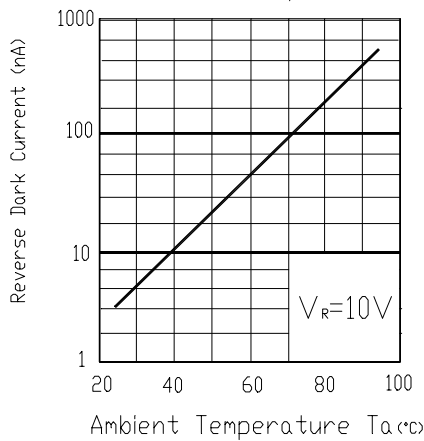

Fig.4 Reverse Light Current vs. E_e

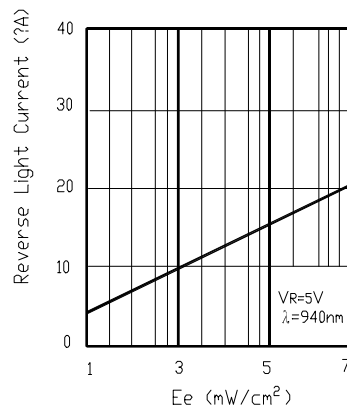

Fig.5 Terminal Capacitance vs. Reverse Voltage

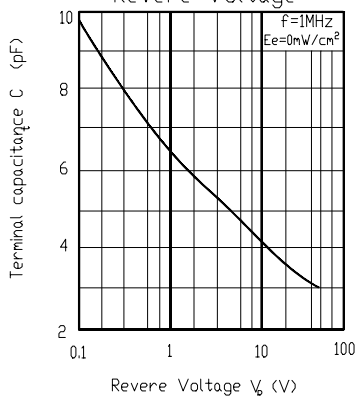
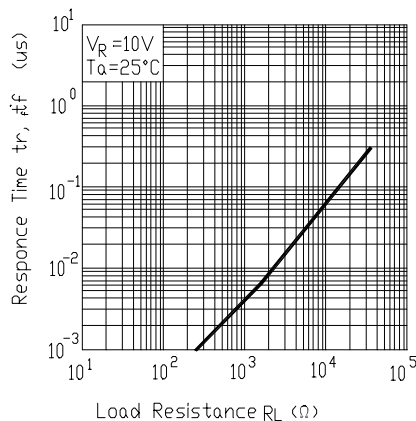

Fig.6 Response Time vs. Load Resistance





EVERLIGHT ELECTRONICS CO., LTD.

DEVICE NUMBER : DPD-020-040 REV : 1.1
 ECN : _____ PAGE : 5/7

3mm Silicon PIN Photodiode

MODEL NO : PD204-6B

■ Reliability Test Item And Condition

The reliability of products shall be satisfied with items listed below.
 Confidence level:90%
 LTPD:10%

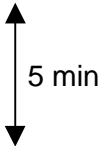
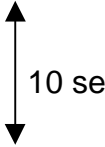
NO.	Item	Test Conditions	Test Hours/ Cycle	Sample Size	Failure Judgement Criteria	Ac/Re
1	Solder Heat	TEMP : 260°C ± 5 °C	5 sec	22 PCs	$I_L \leq L_x \times 0.8$ L :Lower specification limit	0/1
2	Temperature Cycle	H : +85°C 30 min  L : -55°C 30 min	50 cycle	22 PCs		0/1
3	Thermal Shock	H : +100°C 5 min  L : -10°C 5 min	50 cycle	22 PCs		0/1
4	High Temperature Storage	TEMP. : +100°C	1000 hrs	22 PCs		0/1
5	Low Temperature Storage	TEMP. : -55°C	1000 hrs	22 PCs		0/1
6	DC Operating Life	$V_R=5V$	1000 hrs	22 PCs		0/1
7	High Temperature / High Humidity	85°C / 85% R.H.	1000 hrs	22 PCs		0/1

3mm Silicon PIN Photodiode

MODEL NO : PD204-6B

■ Test Method For Reverse Light Current

Condition: $E_e=5\text{mW}/\text{cm}^2, V_R=5\text{V}$

Test Item: Reverse Light Current

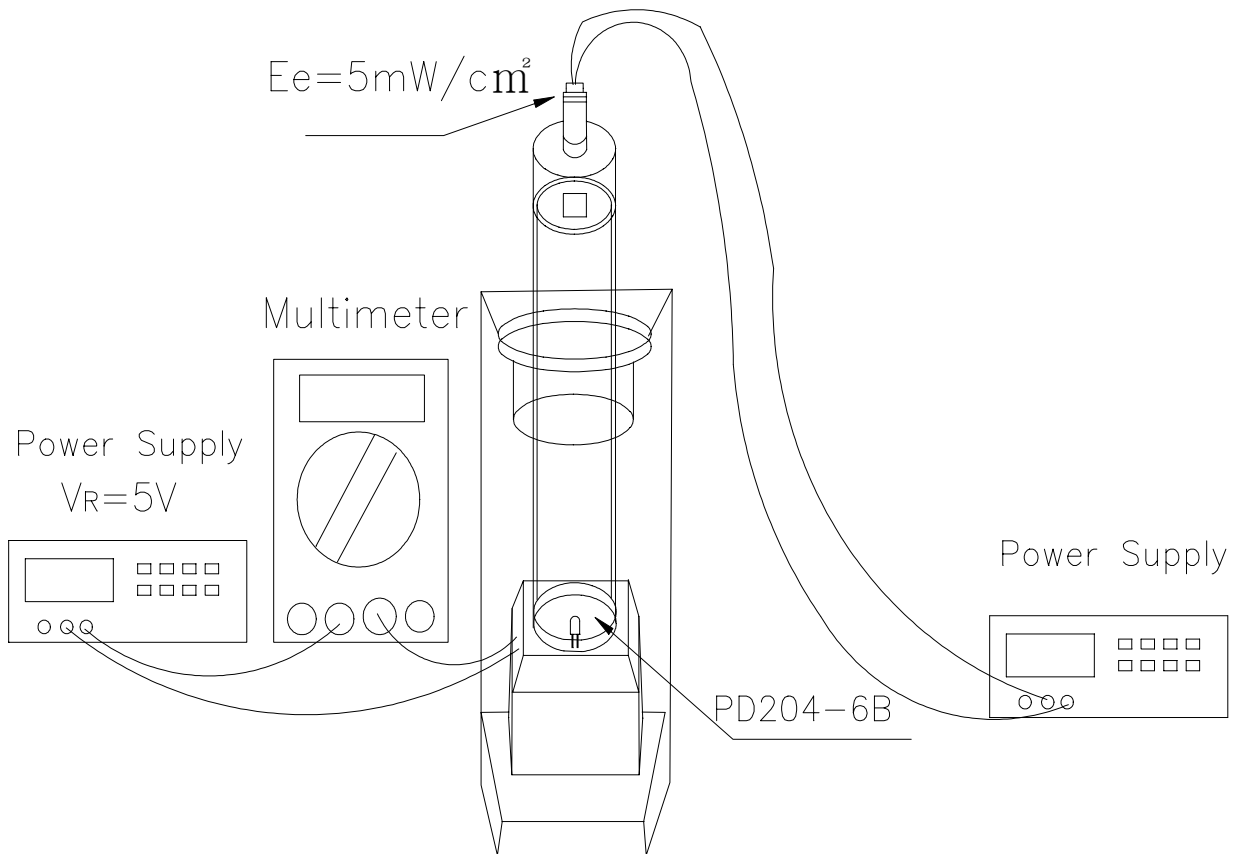
Unit : μA 



DEVICE NUMBER : DPD-020-040 REV : 1.1
ECN : _____ PAGE : 7/7

3mm Silicon PIN Photodiode

MODEL NO : PD204-6B

■ Packing Specifications

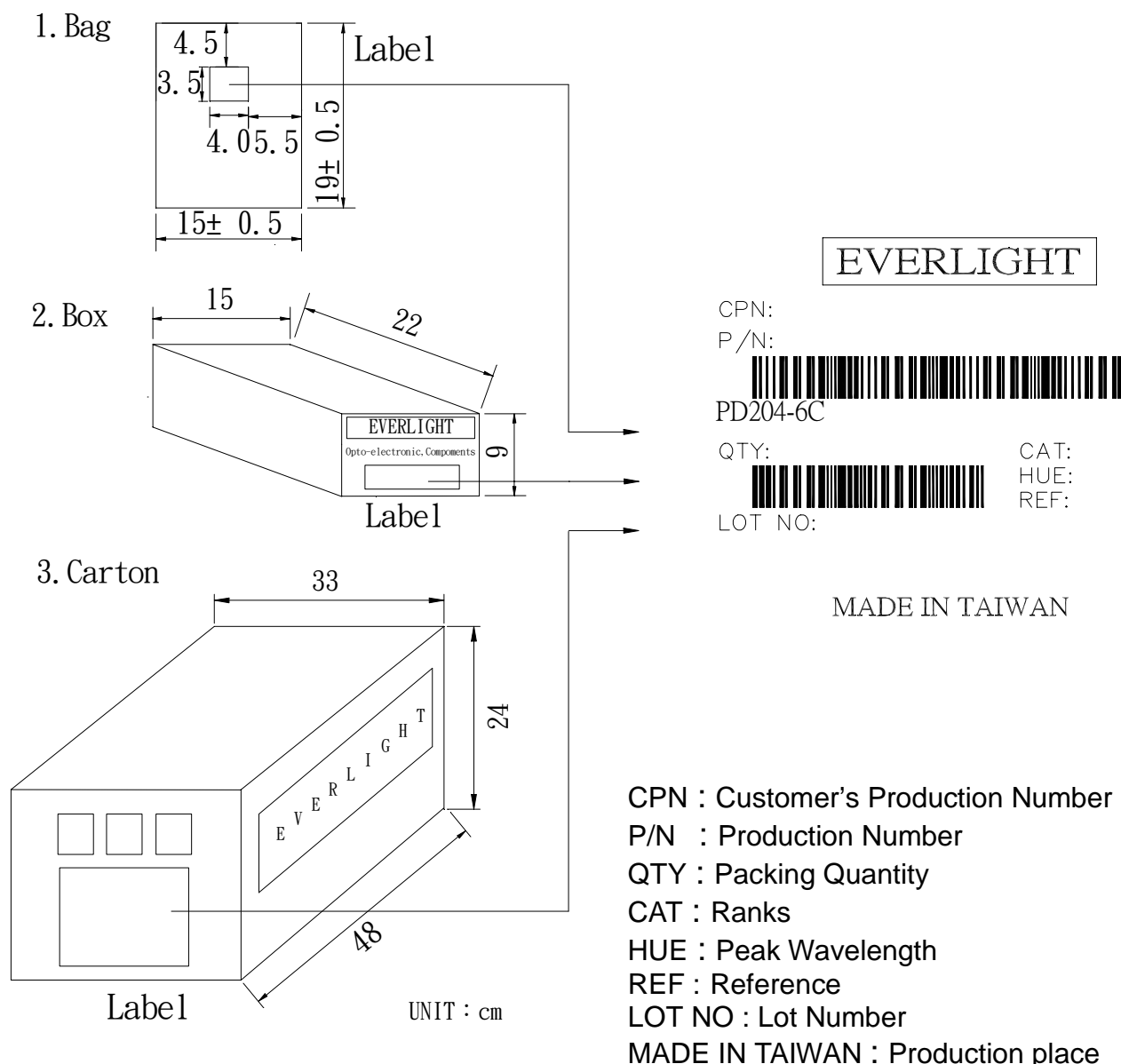

■ Packing Quantity Specification

1. 1000 Pcs/1Bag , 4 Bags/1Box
2. 10 Boxes/1Carton